

HALOS SURFACE

D93247

base number

1. To build a product code in our configurator select the specify button on the base model # product page
2. To build a manual product code on this datasheet choose from the options listed below in blue font and add the suffix to the base model #

GENERAL

Series: Halos _____
Brand: Milan _____
Division: Design _____
Mounting Type: Surface _____
Mounting Location: Wall _____

PHYSICAL

Shape: Round _____
Diameter (mm): 200 _____
Diameter (in): 7 7/8 _____
Height (mm): 200 _____
Depth (mm): 58 _____
Height (in): 7 7/8 _____
Depth (in): 2 5/16 _____
Light Distribution: Omnidirectional _____
Weight (kg): 0.5 _____
Weight (lbs): 0.999 _____
Diffuser: Satin Glass _____
Fixture Finish: MBQ _____
Fixture Material: Glass / Metal _____

ELECTRICAL

Lamp Type: LED _____
Input Wattage (W): 9.6 _____
Dimming: Electronic Low Voltage Dimming _____
Input Voltage (V): 120Vac Direct Line _____

LED

Color Temperature (°K): 3000 _____
Max. Delivered Lumen (lm): 893 _____
CRI: >90 CRI _____
Lamp Life (hrs): 50000 _____

OPTICAL

RATINGS AND CERTIFICATIONS

Certified By: CSA Certified to UL and CSA Standards _____
IP rating: IP20 _____

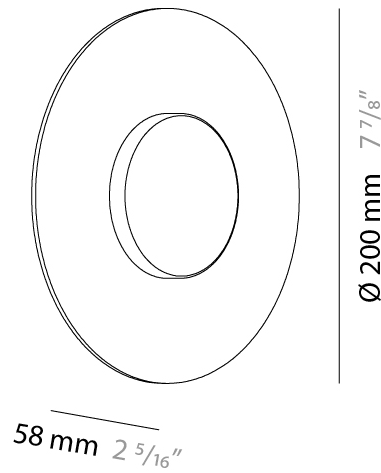
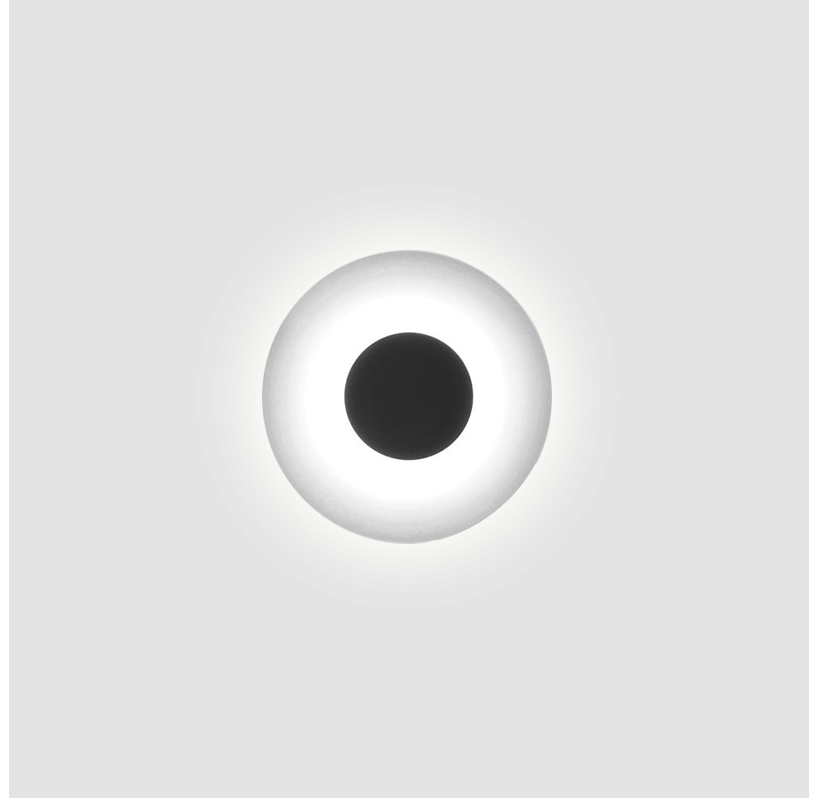

D93247

PROJECT

TYPE

SPECIFIER

QUANTITY

DATE



D

HALOS SURFACE

D93248

base number

- To build a product code in our configurator select the specify button on the base model # product page
- To build a manual product code on this datasheet choose from the options listed below in blue font and add the suffix to the base model #

GENERAL

Series: Halos
Brand: Milan
Division: Design
Mounting Type: Surface
Mounting Location: Wall

PHYSICAL

Shape: Round
Diameter (mm): 365
Diameter (in): 14 ³/₈
Height (mm): 365
Depth (mm): 63
Height (in): 14 ³/₈
Depth (in): 2 ¹/₂
Light Distribution: Omnidirectional
Weight (kg): 2.0
Weight (lbs): 4.499
Diffuser: Satin Glass
Fixture Finish: MBQ
Fixture Material: Glass / Metal

ELECTRICAL

Lamp Type: LED
Input Wattage (W): 9.6
Dimming: Electronic Low Voltage Dimming
Input Voltage (V): 120Vac Direct Line

LED

Color Temperature (°K): 2700
Max. Delivered Lumen (lm): 893
CRI: >90 CRI
Lamp Life (hrs): 50000

OPTICAL

RATINGS AND CERTIFICATIONS

Certified By: CSA Certified to UL and CSA Standards
IP rating: IP20

PROJECT	_____
TYPE	_____
SPECIFIER	_____
QUANTITY	_____
DATE	_____

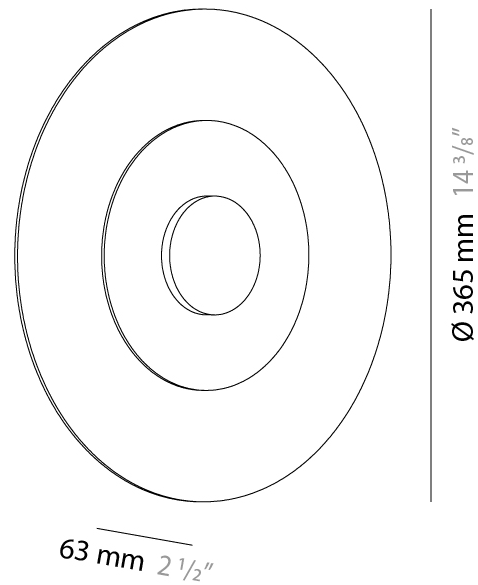

D93248

PROJECT

TYPE

SPECIFIER

QUANTITY

DATE

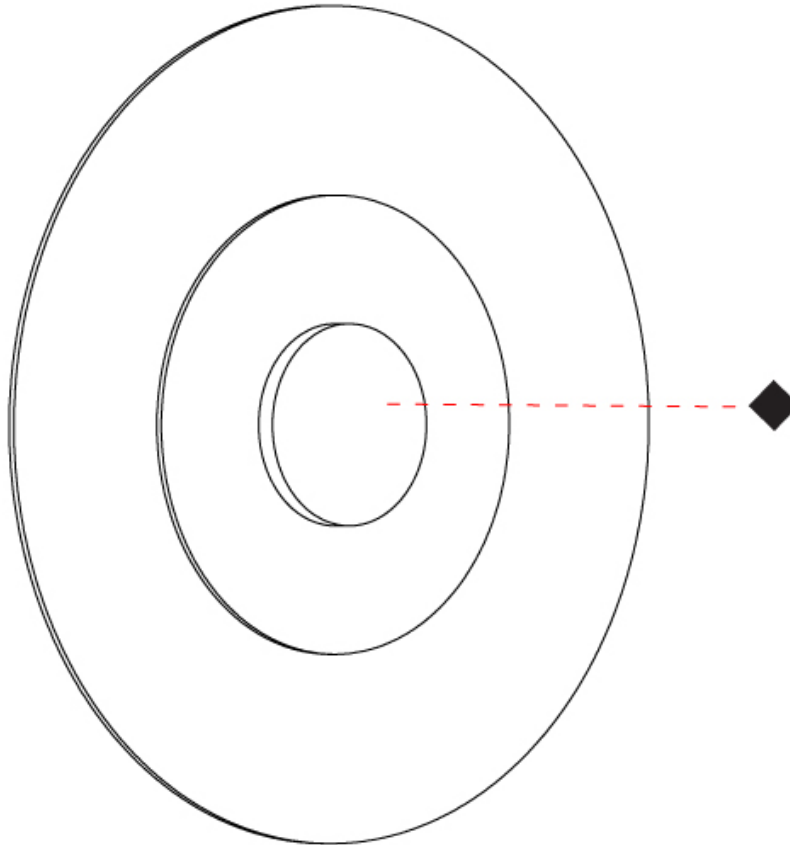

D

PROJECT	
TYPE	
SPECIFIER	
QUANTITY	
DATE	

HALOS PORTABLE

D94051

base number

- To build a product code in our configurator select the specify button on the base model # product page
- To build a manual product code on this datasheet choose from the options listed below in blue font and add the suffix to the base model #

GENERAL

Series: Halos
 Brand: Milan
 Division: Design
 Mounting Type: Portable
 Mounting Location: Table
 Subcategory: Table

PHYSICAL

Shape: Round
 Diameter (mm): 365
 Diameter (in): 14 ³/₈
 Height (mm): 365
 Depth (mm): 98
 Height (in): 14 ³/₈
 Depth (in): 3 ⁷/₈
 Light Distribution: Omnidirectional
 Weight (kg): 1.8
 Weight (lbs): 3.999
 Diffuser: Satin Glass
 Fixture Finish: MBQ
 Fixture Material: Glass / Metal

ELECTRICAL

Lamp Type: LED
 Input Wattage (W): 9.6
 Dimming: Electronic Low Voltage Dimming
 Input Voltage (V): 120Vac Direct Line

LED

Color Temperature (°K): 2700
 Max. Delivered Lumen (lm): 893
 CRI: >90 CRI
 Lamp Life (hrs): 50000

OPTICAL

RATINGS AND CERTIFICATIONS

Certified By: CSA Certified to UL and CSA Standards
 IP rating: IP20

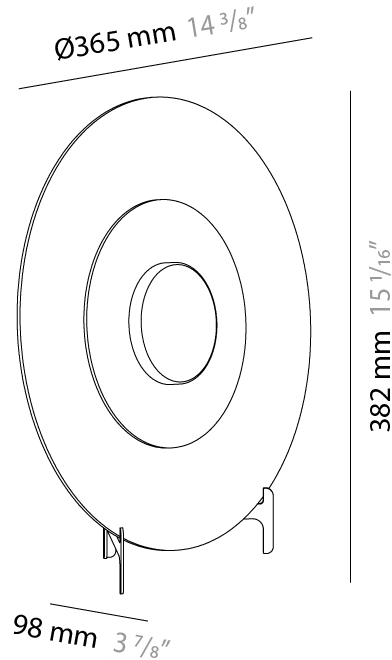
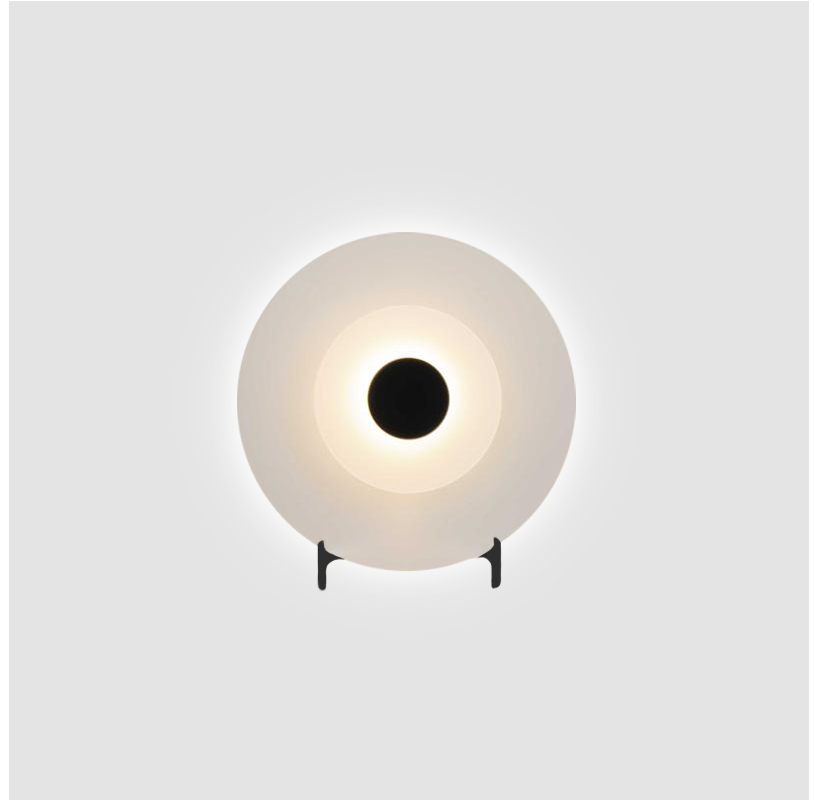

D94051

PROJECT

TYPE

SPECIFIER

QUANTITY

DATE

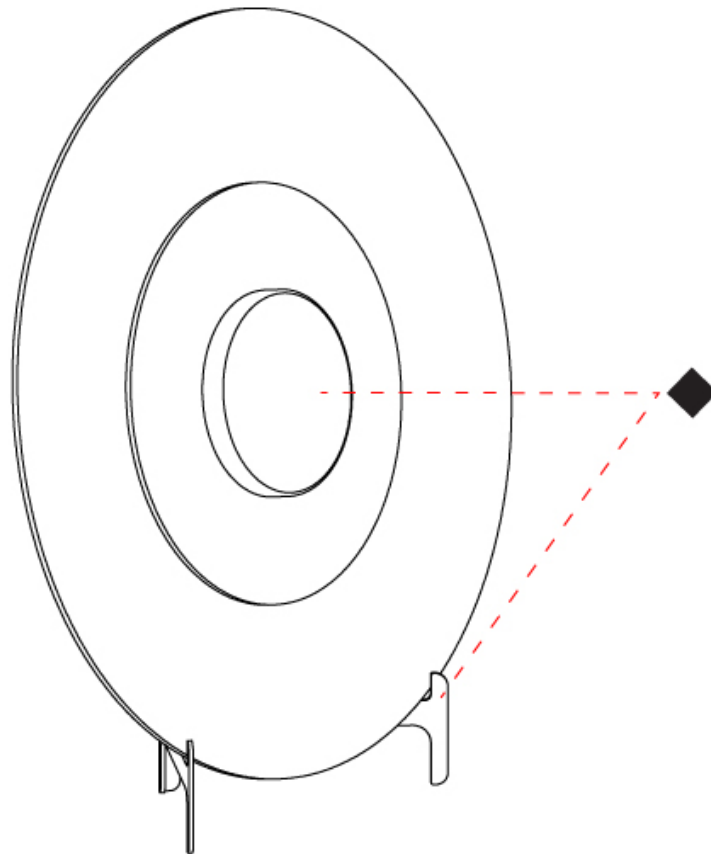

D

HALOS PORTABLE

D94052

base number

- To build a product code in our configurator select the specify button on the base model # product page
- To build a manual product code on this datasheet choose from the options listed below in blue font and add the suffix to the base model #

GENERAL

Series: Halos
 Brand: Milan
 Division: Design
 Mounting Type: Portable
 Mounting Location: Floor
 Subcategory: Floor

PHYSICAL

Shape: Round
 Diameter (mm): 365
 Diameter (in): 14 ³/₈
 Height (mm): 1702
 Height (in): 67
 Light Distribution: Omnidirectional
 Weight (kg): 3.7
 Weight (lbs): 7.999
 Diffuser: Satin Glass
 Fixture Finish: MBQ
 Fixture Material: Glass / Metal

ELECTRICAL

Lamp Type: LED
 Input Wattage (W): 9.6
 Input Voltage (V): 120Vac Direct Line

LED

Color Temperature (°K): 2700
 Max. Delivered Lumen (lm): 893
 CRI: >90 CRI

OPTICAL

RATINGS AND CERTIFICATIONS

Certified By: CSA Certified to UL and CSA Standards
 IP rating: IP20

PROJECT	
TYPE	
SPECIFIER	
QUANTITY	
DATE	

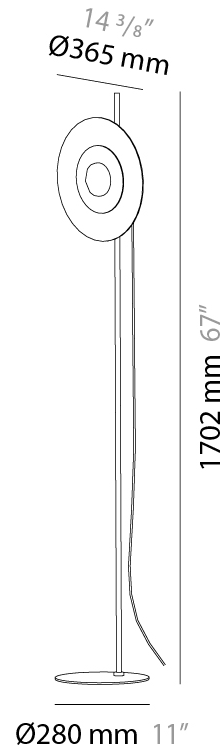

HALOS PORTABLE

D94052

PROJECT _____

TYPE _____

SPECIFIER _____

QUANTITY _____

DATE _____

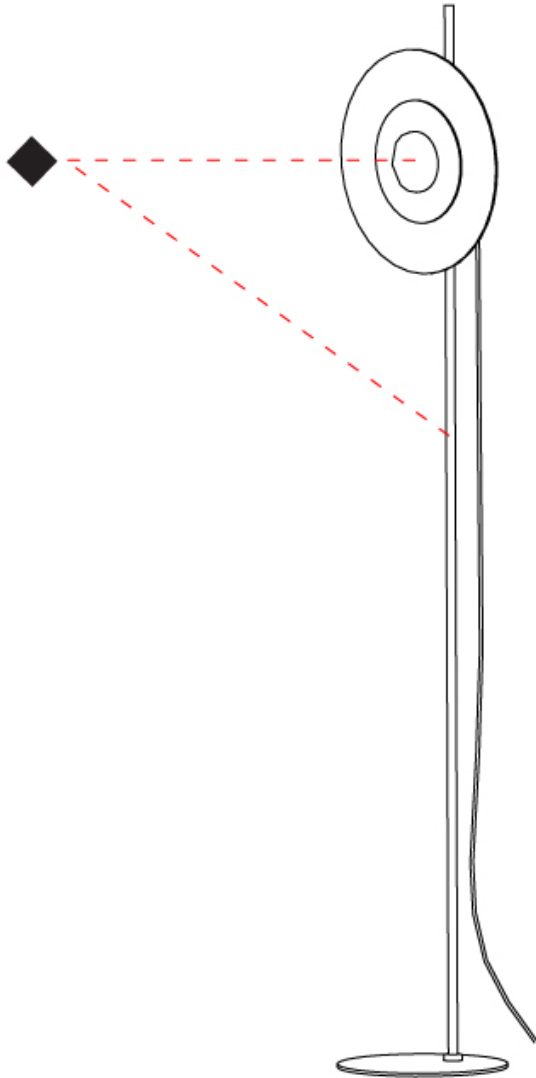

D

HALOS COLOR FINISH CHART

PROJECT

TYPE

SPECIFIER

QUANTITY

DATE

Fixture Finish

Matte Black Lacquer - MBQ

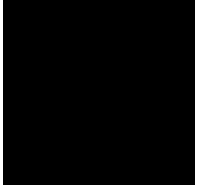





































































Digital: Not all screens are calibrated the same, and therefore, colors will appear differently between screens.

Physical: When texture is involved, there will be variations in color, character and tone within a product series and between product families.













PROJECT	
TYPE	
SPECIFIER	
QUANTITY	
DATE	











LEGEND

	floor-mounted		pivotal		special LED (upon request) RGB, RGBW, tunable, gold+, meat+, art+, fashion+
	wall and ceiling: recessed and surface mounted		rotating		warm dim / natural dimming LED
	ceiling-mounted and wall-mounted		illuminate tilted		rechargeable battery powered
	wall-mounted		color of suspension cable		fixture with natural vivid LED (upon request)
	omni-directional light distribution		length of suspension cable		color rendering index
	direct light distribution		reflector degree selection		color temperature
	direct/indirect light distribution		super spot		lumen (luminous flux)
	indirect light distribution		lens		efficacy (lumens per watt)
	asymmetric light distribution		lens pack		Unified Glare Rating (UGR) range from 5-40
	aura light distribution		shine ring		marine grade (AISI 316 stainless steel)
	round wall or ceiling cut-out		integrated shine ring with diffuser		walk on
	square wall or ceiling cut-out		free individual colors 01-29		drive on
	the supplied jig specifies the cutout dimensions		individual colors: 00 (free of charge), 01-25 (extra charge)		Dark Sky Compliance
	minimum distance (meters) lamp - object		luminaire part to be colored (F1)		Americans with Disabilities Act (less than 4" off the wall located between 27"-84" from floor)
	recessed depth		luminaire part to be colored (F2)		lamp protected against explosion
	ceiling thickness in mm		luminaire part to be colored (F3)		blown glass using traditional methods by master glass blower
	ceiling thickness selection		luminaire part to be colored (F4)		acoustic material
	dimmable DP (phase), DV (0-10V), DD (dali), DS (step-dim)		luminaire part to be colored (F5)		protection class I, protection insulation
	included or excluded LED driver/transformer/control gear		color of 3-circuit adaptor		protection class II, protection insulation
	separately switchable		indirect diffuser		ETL Certified to UL and CSA Standards
	sensor		direct diffuser		UL Certified to UL and CSA Standards
	remote control		ball-proof (upon request)		CSA Certified to UL and CSA Standards
	available upon request		accessory		Certified for North American Standards

IP RATING

	protected against ingress of solid bodies greater than 12.5mm (finger)
	protected against ingress of solid bodies greater than 2.5mm protected against sprays of water up to 60 degrees from the vertical (rain)
	protected against ingress of solid bodies greater than 1mm (wire) no protection against the ingress of moisture
	protected against ingress of solid bodies greater than 1mm (wire) protected against sprays of water up to 60 degrees from the vertical (rain)
	protected against ingress of solid bodies greater than 1mm (wire) protected against water splashed from all directions
	protected against limited ingress of dust (wet rooms/covered outdoor areas) protected against water splashed from all directions
	protected against ingress of dust protected against jets of water
	protected against ingress of dust protected against powerful jets of water or heavy seas
	protected against ingress of dust protected against immersion of water between 15cm - 1m for 30 minutes
	protected against ingress of dust protected against immersion of water under pressure for long periods

IK RATING

	protected against 0.14 joules impact (equivalent to 0.25kg mass dropped from 56mm above the surface)
	protected against 0.2 joules impact (equivalent to 0.25kg mass dropped from 80mm above the surface)
	protected against 0.35 joules impact (equivalent to 0.25kg mass dropped from 140mm above the surface)
	protected against 0.5 joules impact (equivalent to 0.25kg mass dropped from 200mm above the surface)
	protected against 0.7 joules impact (equivalent to 0.25kg mass dropped from 280mm above the surface)
	protected against 1 joules impact (equivalent to 0.25kg mass dropped from 400mm above the surface)
	protected against 2 joules impact (equivalent to 0.5kg mass dropped from 400mm above the surface)
	protected against 5 joules impact (equivalent to 1.7kg mass dropped from 300mm above the surface)
	protected against 10 joules impact (equivalent to 5.0kg mass dropped from 200mm above the surface)
	protected against 20 joules impact (equivalent to 5.0kg mass dropped from 400mm above the surface)